

# Product data sheet

Specifications

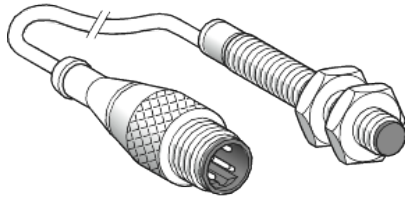

inductive sensor XS5 M8 - L51mm - stainless - Sn1.5mm - 12..48VDC - M12 - 0.8 m

XS508B1DAL08M12

XS508B1DAL08M12 has not been replaced. Please contact your customer care center for more information.

⚠ Discontinued

## Main

|                                    |  |
|------------------------------------|--|
| Range of product                   | Telemecanique Inductive proximity sensors XS               |
| Series name                        | General purpose  |
| Sensor type                        | Inductive proximity sensor                                 |
| Device application                 | -  |
| Sensor name                        | XS5  |
| Sensor design                      | Cylindrical M8   |
| Size                               | 51 mm  |
| Body type                          | Fixed  |
| Detector flush mounting acceptance | Flush mountable  |
| Material                           | Stainless steel  |
| Type of output signal              | Discrete   |
| Wiring technique                   | 2-wire   |
| [Sn] nominal sensing distance      | 1.5 mm   |
| Discrete output function           | 1 NO   |
| Output circuit type                | DC   |
| Electrical connection              | 4 pins M12 remote male connector, pin assignment : 3-4     |
| Cable length                       | 0.8 m  |
| [Us] rated supply voltage          | 12...48 V DC   |
| Switching capacity in mA           | 1.5...100 mA DC with overload and short-circuit protection |
| IP degree of protection            | IP67 conforming to IEC 60529                               |

## Complementary

|                    |                     |
|--------------------|---------------------|
| Thread type        | M8 x 1              |
| Detection face     | Frontal             |
| Front material     | PPS                 |
| Enclosure material | Stainless steel 303 |
| Operating zone     | 0...1.2 mm          |

|                          |                              |
|--------------------------|------------------------------|
| Differential travel      | 1...15% of Sr                |
| Cable composition        | 2 x 0.11 mm <sup>2</sup>     |
| Wire insulation material | PvR                          |
| Status LED               | Output state: 1 LED (yellow) |
| Supply voltage limits    | 10...58 V DC                 |
| Maximum residual current | 0.5 mA open state            |
| Switching frequency      | <= 4000 Hz                   |
| Maximum voltage drop     | <4 V (closed)                |
| Maximum delay first up   | 10 ms                        |
| Maximum delay response   | 0.2 ms                       |
| Maximum delay recovery   | 0.2 ms                       |
| Marking                  | CE                           |
| Threaded length          | 42 mm                        |
| Height                   | 8 mm                         |
| Length                   | 51 mm                        |
| Net weight               | 0.05 kg                      |

## Environment

|                                       |   |
|---------------------------------------|---|
| Product certifications                | UL<br>CSA<br>CCC  |
| Ambient air temperature for operation | -25...70 °C   |
| Ambient air temperature for storage   | -40...85 °C   |
| Vibration resistance                  | 25 gn amplitude = +/- 2 mm (f = 10...55 Hz) conforming to IEC 60068-2-6 |
| Shock resistance                      | 50 gn for 11 ms conforming to IEC 60068-2-27                            |

## Packing Units

|                  |          |
|------------------|----------|
| Package 1 Weight | 0.057 kg |
| Package 1 Height | 0.420 dm |
| Package 1 width  | 0.970 dm |
| Package 1 Length | 1.320 dm |

## Contractual warranty

|          |           |
|----------|-----------|
| Warranty | 18 months |
|----------|-----------|

Dimensions

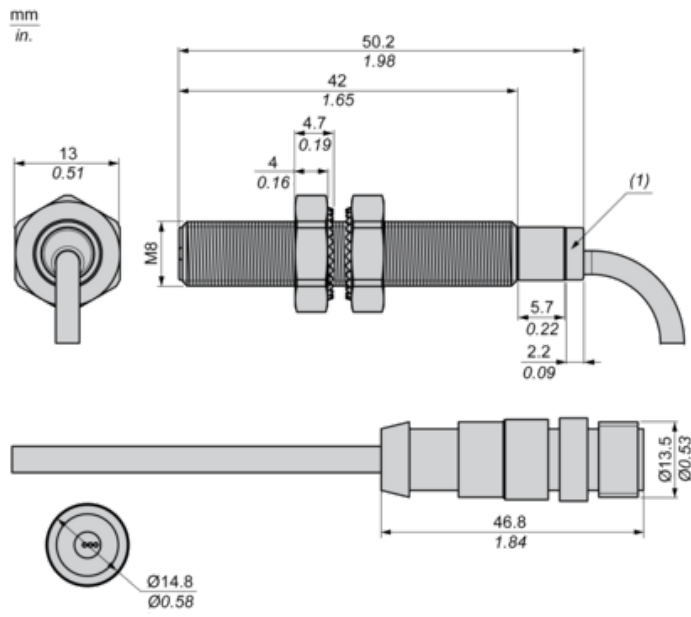

**Minimum Mounting Distances**

---

Side by side

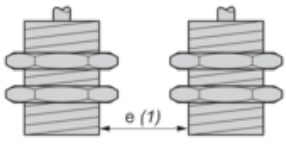

$e (1) \geq 3 \text{ mm}/0.12 \text{ in.}$

Face to face

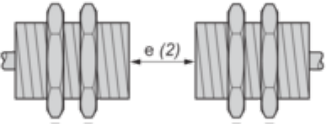

$e (2) \geq 18 \text{ mm}/0.71 \text{ in.}$

Facing a metal object

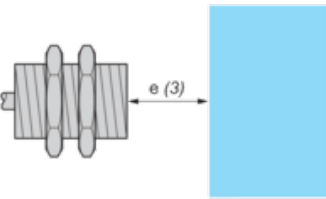

$e (3) \geq 4.5 \text{ mm}/0.18 \text{ in.}$

**Wiring Schemes**

---

**2-Wire Non-polarised**

M12 connector



NO output

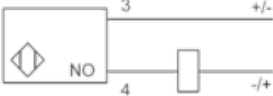

**Performance Curves**

---

**Standard Steel Target : 8x8x1 mm**

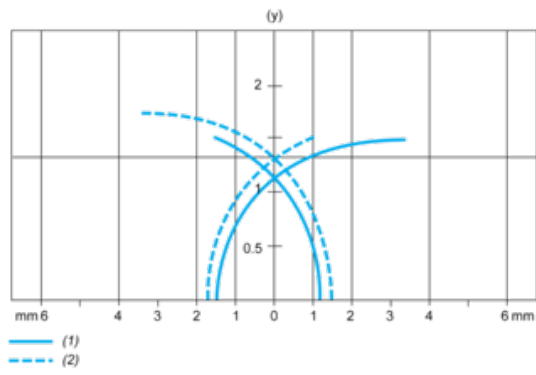

- (1) Pick-up points
- (2) Drop-out points (object approaching from the side)
- (y) Sensing distance in mm